



HOTBEAM 04

500 W IR under-heating system

The HOTBEAM 04 is an extremely compact and efficient under heater. Powered by infrared technology, a 105 x 130 mm² heating area is provided. The under-heating system, which has been tried and tested for many years, was developed for stable, reliable and precise preheating tasks. All operations can be carried out with this device safely and with precision. Various operating modes, e.g. for consistent power, consistent temperature and profiles, can be operated easily. The Auto-Profiler

feature determines required device settings (profile) automatically for the user. The innovative heating-management system guarantees the highest degree of reliability. Furthermore, the under-heating system can control devices (e.g. for removal by suction) or configure them in such a way that they become activated by external devices (SPS or foot switches). The EASYBEAM software allows for the sorting, editing and writing of profiles via a USB connection.

Top Features

Flat and compact



Flexibility

Preheating circuit board for the subsequent Rework process, through to curing and cracking of underfill



Process reliability

Various operating modes, e.g. for consistent power, consistent temperature and profiles



Performance

HOTBEAM and SMART DESOLDER combination for the perfect rework



Plug and Play

Compact format, innovative design and intuitive operation



Process control

Use of temperature profiles via PC software



Ergonomic workstation

Table mount available

Standard equipment

- Under heater HOTBEAM 04.1
- Four PCB support brackets
- Thermocouple sensor (Type K)
- Manual

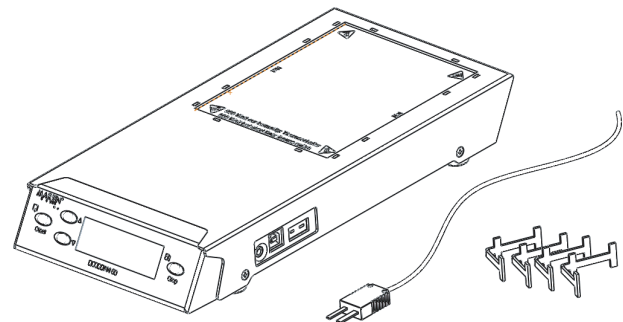











Technical details



Power consumption:	600 VA	
Power under-heating system:	500 W	4 x IR-lamps
Size under-heating system:	105 x 130 mm ²	
Max. PCB size:	130 x 150 mm ²	
Temperature range:	50°C-250°C	1°C steps

Mains:	1 Phase, 85 - 250 VAC, 50 - 60 Hz
Cooling:	Electrically, 2 x fans
Dimensions:	150 x 300 x 40 mm ³
Weight:	800 g

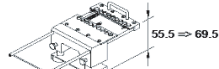
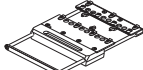
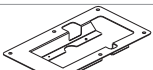
HOTBEAM 04: Optional extras

	Article nr.	Name
	SF03.0001	PCB magnet holder h=20mm for installation set HB 03/04/05
	SF03.0002	PCB magnet holder h=55.5mm for HB 03/04, Handy Fix
	SF03.0012	PCB magnet holder Easy Lock h=55.5mm (snap) for HB 03/04, Handy Fix
	SF03.0005	PCB magnet holder adjustable H=55.5=>69.5mm, for HB 03/04, Handy Fix
	SF03.0011	PCB support rail for HB03/04 Handy Fix, h=55,5mm, l=223mm
	SF03.0013	PCB support rail, h=20mm, l=223mm for installation set HB 03/04/05
	SF33.0014	PCB magnet holder rail for HB03/04, h=55,5mm, l=300mm
	SF33.0015	PCB magnet holder rail, h=20mm, l=300mm for installation set HB03/04/05
	SF01.0100	PCB clip for large pcbs onto IRF handrest
	HF00.0018	Handy Fix 03/05/06 - Base plate only 280*380mm
	HF00.0003	Handy Fix 03 - Base plate 280*380mm 4x magnet holder h=55.5mm
	SF04.0020	PCB clamping holder with 3 fingers adjustable h=55.5=>69.5mm, for HB 03/04, Handy Fix
	SF03.0018	PCB clamping holder with 3 fingers for installation set HB 03/04/05, h=20mm
	HB00.1005	Table mount (flush mount) HOTBEAM 04 Installation set incl. cover panel Consumables

Consumables

	HT00.0009	Flux Pen lead free 0405 C, no clean, RELO
	HT00.0119	Flux Creme lead free 18g 0506 MA, no clean, RELO, with brush
	HT00.0062	Kapton tape 19mm*5.5m

More accessories and consumables at www.martin-smt.de